

systemtronic datasheet BEN



General description:

Ben, versatile, compact auxiliary furniture, easy to move.
It stands out for the size of its wheels finished in natural oak and its knob made of solid natural oak wood.
Manufactured in painted steel finished with thermo-hardened powder paint lacquered in the oven.

Designer: Estudio Enblanc.

Year of launch: 2019.

Technical description:





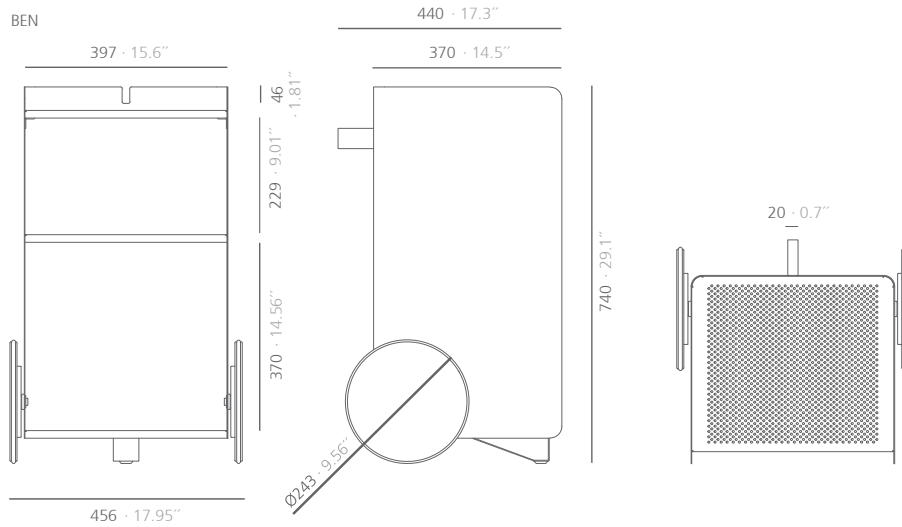

Material: Steel.

Dimensions: 456x440x740mm 17.95x17.3x29.1"

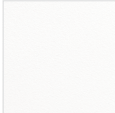

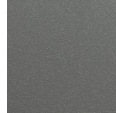
mm · inches

Finishes:

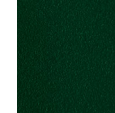
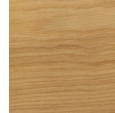
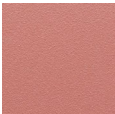
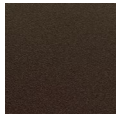
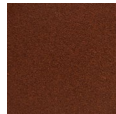
Structure								Knob and wheels
								
textured white	textured black RAL 9011	textured forged grey	matte grey beige RAL 1019	textured blue RAL 5011	textured red RAL 3001	textured garnet RAL 3005	textured green RAL 6009	natural oak
								
textured red sirung	textured bronze bagana	textured rust rame						

*Polyester paint

For its use in humid zones, an additional primer process is required before the paint.
For finishes and special dimensions please consult.

Maintenance:**-Wood:**

We recommend using a cloth or cleaning products for natural wood. Avoid using products containing solvents and/or alcohol.

-Polyester Paint:

For dry dirt (dust), use a damp cloth. For greasy/oily stains (fingerprints), wipe with a sponge with water and dishwashing liquid. Rinse with a damp cloth. Avoid using products containing solvents and/or pure ethyl alcohol.

-Aluminum-metal-glass-melamine-plastic:

We recommend using normal cleaning products for delicate surfaces. Alcohol, solvents and abrasive agents must be avoided.

Sustainability:

The used paints do not contain solvents, do not consume water and do not generate emissions or waste. The result is a lower environmental impact.