

systemtronic

datasheet ELICA



General description:

Coat rack formed by an anodized aluminum column and hangers and base made of painted steel.

Our original Elica has two new family members: Elica umbrella with the double function of umbrella stand and coat rack where the container is made of aluminum; and Elica mini, a steel light weight, portable and of personal use coat rack, so whenever you are sitting down in a restaurant, library, cafe or in your work place, you can have your belongings near.

Diseñador: Fernando Gil.



Technical description:

Materials:

Hangers: Steel.
 Column: Estruded aluminum.
 Container of Elica Umbrella: aluminum.
 Base: steel.

Dimensions: Ø325x1779 mm

ELICA: Ø325x1880 mm Ø12.8" x71.3"

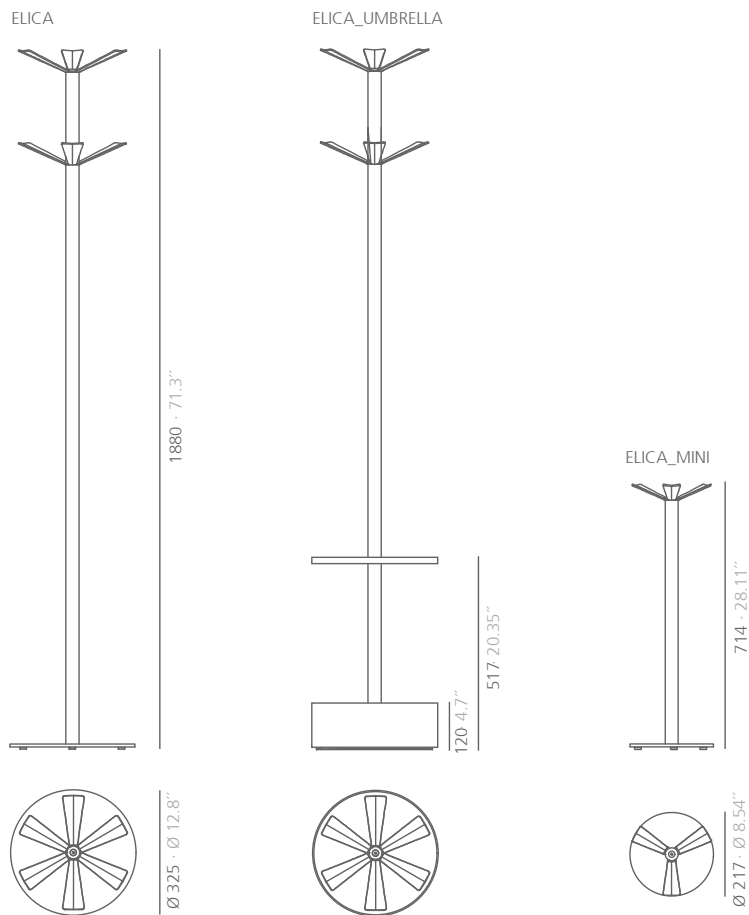

ELICA_UMBRELLA: Ø325x1880 mm Ø12.8" x71.3"

ELICA_MINI: Ø217x930 mm Ø8.54" x36.6"



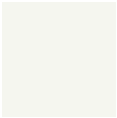
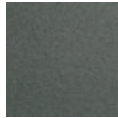

SI units: mm and inches

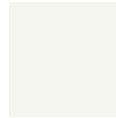
Elica and Elica Umbrella:

Base and hagers			Column	
				
white gloss	textured forge grey	satin black RAL 9011	anodized aluminum	white gloss
*Polyester paint				

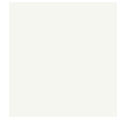
Elica Mini:

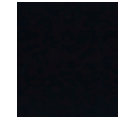
		
white gloss	textured forge grey	satin black RAL 9011
*Polyester paint		

Consult for special dimensions or any other modification.

Maintenance:

-Polyester Paint:

For dry dirt (dust), use a damp cloth. For greasy/oily stains (fingerprints), wipe with a sponge with water and dishwashing liquid. Rinse with a damp cloth. Avoid using products containing solvents and/or pure ethyl alcohol.

-Aluminium-metal-glass-melamine-plastic:

We recommend using normal cleaning products for delicate surfaces. Alcohol, solvents and abrasive agents must be avoided.

Assembly for Elica Umbrella

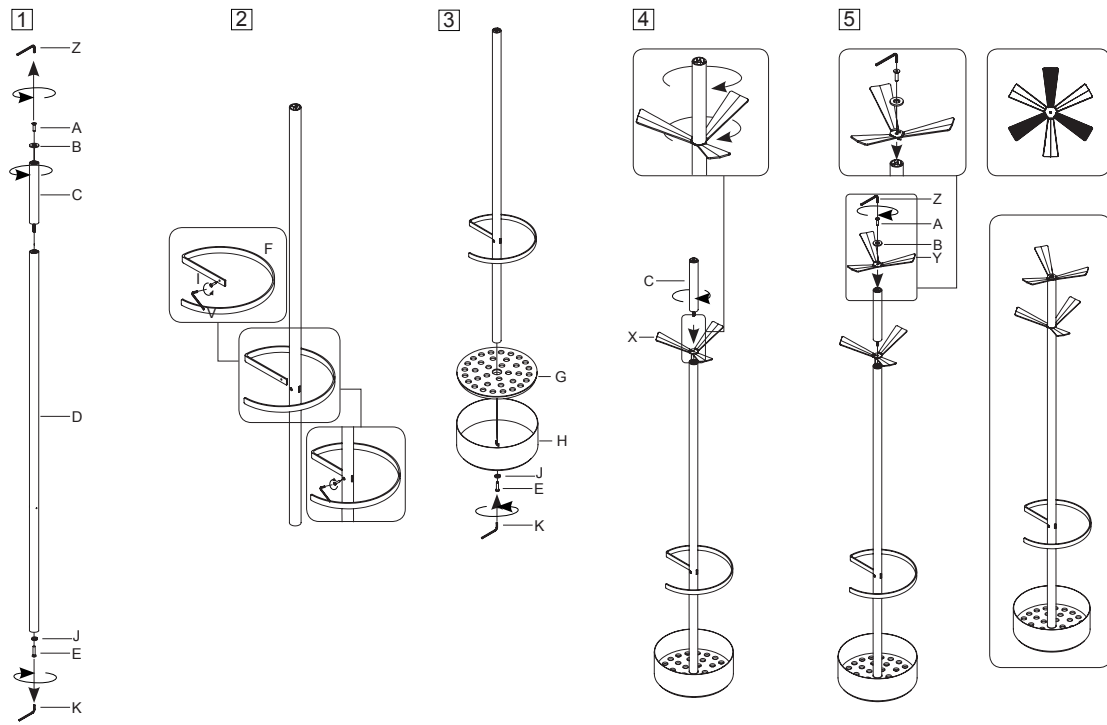

Assembly for Elica

